



5" Video Baby Monitor with Night Light

LF2415



Parent Guide

This guide contains important information.
Please keep it for future reference.

**Visit our website leapfrog.com/en-gb/ for more information about products, downloads, resources and more.
Read our complete warranty policy online at <https://www.leapfrog.com/en-gb/legal>.**



**Scan the QR code
for more online
support:**



Or go to leapfrog.com/en-gb/support

Important Safety Instructions

The applied name plate is located at the bottom of the Baby Unit's base. When using your equipment, basic safety precautions should always be followed to reduce the risk of fire, electric shock and injury, including the following:

1. Follow all warnings and instructions marked on the product.
2. Adult setup is required.
3. **CAUTION:** Do not install the Baby Unit at a height above 2 metres.
4. This product is intended as an aid. It is not a substitute for responsible and proper adult supervision and should not be used as such.
5. This product is not intended for use as a medical monitor.
6. Do not use this product near water, for example, near to a bath, sink, swimming pool or shower.
7. **CAUTION:** Use only the internally, non-user replaceable battery fitted to the Parent Viewer. There may be a risk of explosion if a wrong type of battery is used for the Parent Viewer. The battery cannot be subjected to high or low extreme temperature and low air pressure at high altitude during use, storage or transportation. Disposal of battery in fire or a hot oven, mechanically crushing or cutting or the battery can result in an explosion. Leaving the battery in an extremely high temperature surrounding environment can result in an explosion or the leakage of flammable liquid or gas. Battery subjected to extremely low air pressure may result in an explosion or the leakage of flammable liquid or gas. Dispose of used batteries according to the instructions.
8. Use only the adaptors included with this product. Incorrect adaptor polarity or voltage can seriously damage the product. Use only the adaptors and battery listed below.



Power adaptor information:

Baby Unit Output: 5V DC 600mA;
VTech Telecommunications Ltd.; Model: VT05EUK05060
Parent Viewer Output: 5V DC 1A;
VTech Telecommunications Ltd.; Model: VT05EUK05100



Rechargeable battery information:



Zhuhai Great Power Energy Co., Ltd.
Li-ion battery, 3.6V, 2600mAh, 9.36Wh;
Model: ICR18650-2.6Ah-3.6V-1S1P

9. The power adaptors are intended to be correctly oriented in a vertical or floor mount position. The prongs are not designed to hold the plug in place if it is plugged into a ceiling, under-table or cabinet outlet.
10. For pluggable equipment, the socket-outlet shall be installed near the equipment and shall be easily accessible.
11. Unplug this product from the wall outlet before cleaning.
12. Do not use liquid or aerosol cleaners. Use a damp cloth for cleaning. Do not modify the power adaptors or replace with other adaptors.
13. Do not allow anything to rest on the power cords. Do not install this product where the cords may be walked on or crimped.
14. This product should be operated only from the type of power source indicated on the marking label. If you are not sure of the type of power supply in your home, consult your dealer or electricity supply provider.
15. Do not overload wall outlets or use an extension cord.
16. Do not place this product on an unstable table, shelf, stand or other unstable surfaces.
17. This product should not be placed in any area where proper ventilation is not provided. Slots and openings in the back or bottom of this product are provided for ventilation. To protect them from overheating, these openings must not be blocked by placing the product on a soft surface such as a bed, sofa or rug. This product should never be placed near or over a radiator or heat source.

18. Never push objects of any kind into this product through the slots because they may touch dangerous voltage points or create a short circuit. Never spill liquid of any kind on the product.
19. To reduce the risk of electric shock, do not disassemble this product, but take it to an authorised service facility. Disassembling or removing parts of the product other than via the battery door may expose you to dangerous voltages or other risks. Incorrect reassembling can cause electric shock when the product is subsequently used.
20. You should test the sound reception every time you turn on the units or move one of the components.
21. Periodically examine all components for damage.
22. There is a very low risk of privacy loss when using certain electronic devices, such as baby monitors, cordless telephones, etc. **To protect your privacy, make sure the product has never been used before purchase, reset the baby monitor periodically by powering off and then powering on the units, and power off the baby monitor if you are not intending to use it for some time.**
23. Children should be supervised to ensure that they do not play with the product.
24. The small parts of this monitor can be swallowed by babies or small children. Keep these parts out of reach of children.
25. The product is not intended for use by persons (including children) with reduced physical, sensory or mental capabilities, or lack of experience and knowledge, unless they have been given supervision or instruction concerning use of the appliance by a person responsible for their safety.

SAVE THESE INSTRUCTIONS

Cautions

1. Use and store the product at a temperature between 0°C and 40°C.
2. Mishandling batteries can cause burn, fire or explosion hazards.
3. Do not expose the product to extreme cold, heat or direct sunlight. Do not put the product close to a heating source.
4. Batteries should not be exposed to excessive heat such as bright sunshine or fire.
5.  **Warning—Strangulation Hazard—Children have STRANGLED in cords. Keep this cord out of the reach of children. Do not remove this Do not remove warning label on the adaptor cord.** 
6. Never place the Baby Unit(s) inside the baby's cot or playpen. Never cover the Baby Unit(s) or Parent Viewer with anything such as a towel or a blanket.
7. Other electronic products may cause interference with your baby monitor. Try installing your baby monitor as far away from these electronic devices as possible: wireless routers, radios, cellular telephones, intercoms, room monitors, televisions, personal computers, kitchen appliances and cordless telephones.

What's Included

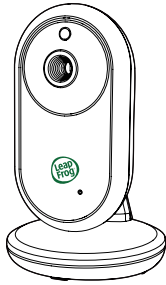
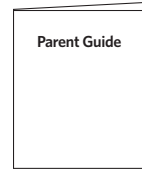
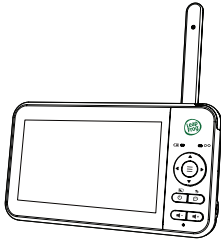

Connect and Charge the Baby Monitor

1. Connect the Baby Monitor

Note:

- Baby Unit turns on automatically after it connects to the power socket.

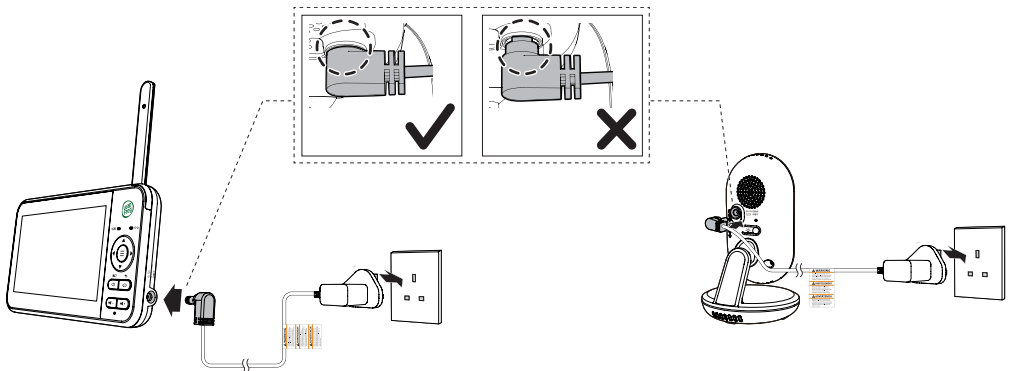



2. Charge the Parent Viewer Battery

Notes:

- Before using the baby monitor for the first time, charge the Parent Viewer battery for 12 hours. When the Parent Viewer battery is fully charged, the battery icon segments are solid .
- The standby time varies depending on your actual usage time and the age of the battery.



The battery icon on the screen indicates the battery status:

| Battery Indicators | Battery Status | Action |
|--|--|--|
| The screen displays  . The red  light flashes. | The battery is low in power and may only be used for a short time. | Charge without interruption (about 30 minutes). |
| The battery icon segments are solid  . | The battery is fully charged. | To keep the battery charged, connect it to AC power when in use. |

3. Power On or Off the Baby Monitor

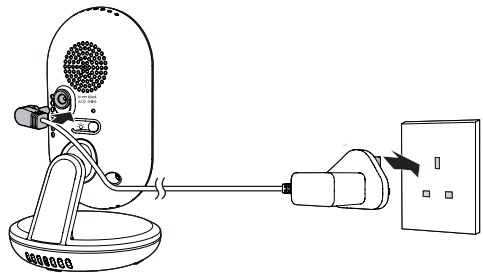
- Connect the power adaptor to the Baby Unit and a power supply to power on the unit.
- Disconnect from the power supply to power off.



- Press and hold  until the welcome screen appears. The  LINK LED light flashes green.



4. Status Check

Once your Baby Unit and Parent Viewer are powered on and connected, your Parent Viewer displays video from Baby Unit, and the  LINK LED lights steadily.

5. Positioning the Baby Monitor

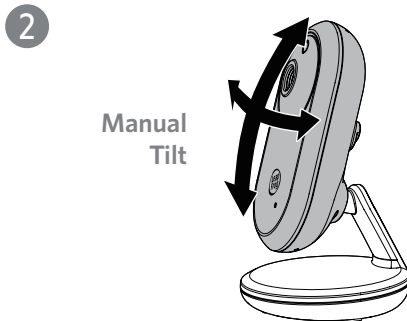
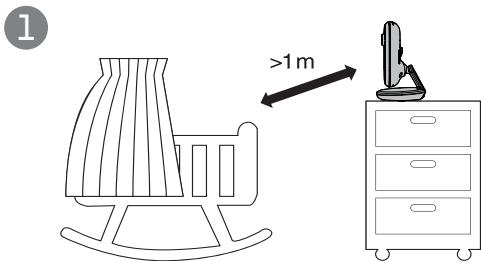

Caution:

Keep the baby unit out of the reach of your baby. Never place or mount the baby unit inside the baby's cot or playpen.

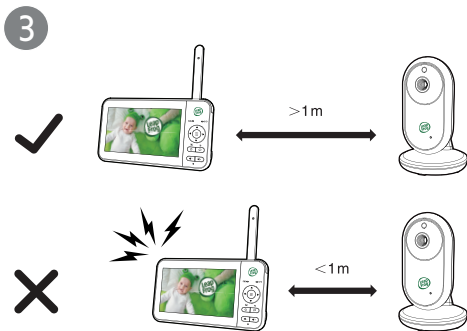

Note:

To avoid interference from other electronic devices, place your baby monitor at least 1 metre away from devices such as wireless routers, microwaves, mobile phones and computers.

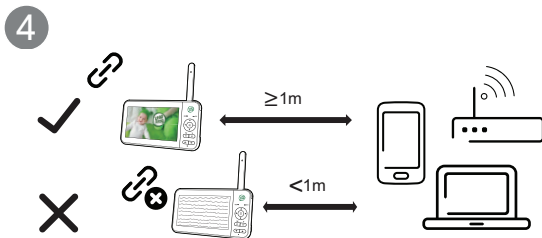

Caution:

The default volume of your Parent Viewer is level 3, and the maximum volume is level 5. If you experience feedback noise from your baby monitor while positioning:

- Make sure your Baby Unit and Parent Viewer are more than 1 metre apart, **OR**
- Lower the volume of your Parent Viewer.

Overview

Parent Viewer

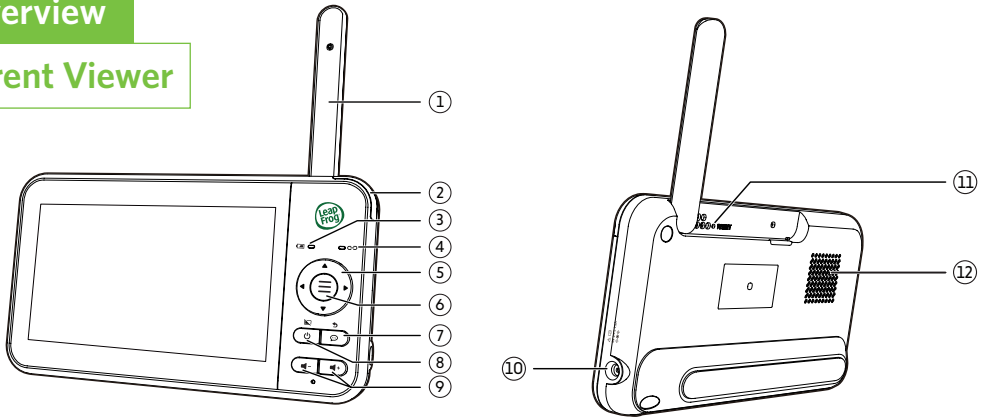

- | | | | | | |
|---|-------------------------------|---|-------------------|----|--------------|
| 1 | Antenna | 5 | Arrow keys | 9 | +VOL -/VOL + |
| 2 | 3-level sound indicator light | 6 | MENU/SELECT | 10 | Power jack |
| 3 | Battery LED light | 7 | RETURN/TALK | 11 | RESET |
| 4 | LINK LED light | 8 | LCD off/POWER key | 12 | Speaker |

Baby Unit

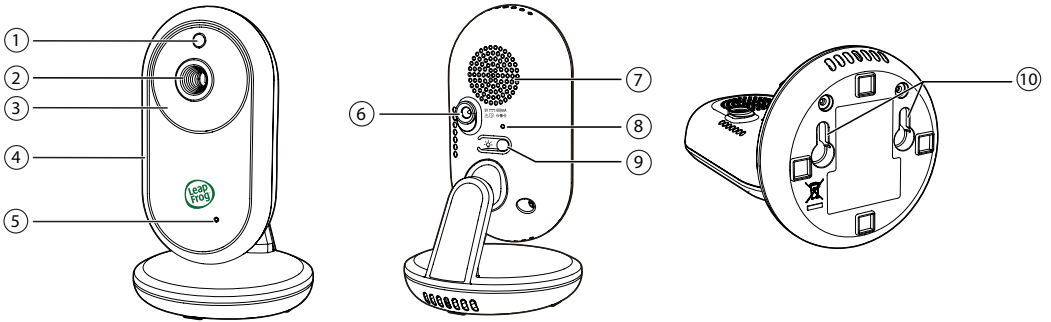

- | | | | |
|---|---------------|----|---|
| 1 | Light sensor | 8 | PAIR key <ul style="list-style-type: none"> The Parent Viewer and Baby Unit provided are already paired |
| 2 | Camera lens | 9 | Night light control key <ul style="list-style-type: none"> Press to turn the night light on or off. |
| 3 | Infrared LEDs | 10 | Slots for wall mounting |
| 4 | Night light | | |
| 5 | Microphone | | |
| 6 | Power jack | | |
| 7 | Speaker | | |

Parent Unit Icons

Main Menu Icons

Brightness



Adjusts the Parent Viewer LCD screen brightness.

Lullaby



Play/Stop



Select to play one of the four soothing sounds.



1 2 3 4 5 ↺

Select to play one of the five melodies or play all.



60min 45min 30min 15min OFF

Set a timer to stop the lullaby, or play non-stop.

Night Light



Turn on/off night light.



1 2 3 4 5 6 7 A

Select from 7 night light colours or auto-colour change.



60min 30min 15min OFF AUTO

Set a timer to turn off the night light or auto-on when sound detected.



Turn on/off auto adaptive brightness.

Screen off Timer



OFF 5min 30min 60min

- Turn the screen off timer OFF, or set the screen to turn off after 5, 30 or 60 minutes when no sound is detected.

AUTO

- Select AUTO to set the Sound Sensitivity level for auto screen on when a sound is detected over the set level. The screen will turn off after 50 seconds of no sound detection.

Alert settings



Turn on/off Low battery alert tone.



Turn on/off Link lost alert tone.



Turn on/off Confirmation alert tone.

Temperature



Turn on/off temperature alert.



Select the minimum and maximum temperature range.



Set the temperature display format.

Camera settings



Adjust the Baby Unit speaker volume.



Zoom

Status icon



Connection status



Current view status

- The Baby Unit that is being viewed.



Night light is turned on.



Auto night light brightness is activated.



Zoom is turned on.



Night vision is turned on.



Melodies and soothing sounds are playing.



Talkback is on.



Sound level indicator



Parent unit is muted.



Temperature alert is turned on.



25°C Temperature measured at Baby Unit.



Battery level indicator



Low battery indicator

General Product Care

To keep this product working well and looking good, follow these guidelines:

- Avoid placing it near heating appliances and devices that generate electrical noise (for example, motors or fluorescent lamps).
- DO NOT expose it to direct sunlight or moisture.
- Avoid dropping the product or treating it roughly.
- Clean with a soft damp cloth.
- DO NOT immerse the Parent Viewer and the Baby Unit in water and do not clean under running water.
- DO NOT use solvents, household cleaning sprays, or liquid cleaners.
- Make sure the Parent Viewer and the Baby Unit are dry before reconnecting to the mains.

Storage

If you are not going to use the video baby monitor for for some time, store the Parent Viewer, the Baby Unit, and the adaptors in a cool, dry place.

Customer Service and Product Warranty



PRODUCT WARRANTY

Thank you for choosing this quality product from VTech.

1. The product detailed above is covered by a one year warranty from the date of purchase, against any defects in materials or workmanship.
2. The product may be returned to the place of purchase.
3. If the product covered by this warranty is damaged due to misuse, modification or unauthorized repair, or because of faulty batteries, battery discharge or incorrect electrical connections, then this warranty becomes void.
4. This warranty is personal to the original purchaser and is not transferable.
5. Breakages to the LCD screen are not covered by the warranty.

Email: service-ukbm@vtechphones.eu

VTech Electronics Europe Plc, c/o XPO Logistics, Warehouse 350, Cat & Fiddle Lane, West Hallam, DE7 6HE

THIS WARRANTY IS OFFERED AS AN EXTRA BENEFIT AND DOES NOT AFFECT CONSUMERS' STATUTORY RIGHTS.

This warranty is valid for the UK and Ireland only. For products purchased outside the UK and Ireland, please contact your local distributor or place of purchase.

IMPORTANT

Please retain this booklet with your sales receipt as proof of the date of purchase.

Manufacturer: VTech Telecommunications Ltd. 23/F, Tai Ping Industrial Centre, Block 1, 57 Ting Kok Road, Tai Po, Hong Kong.

Importer: VTech Electronics Europe Plc. Napier Court, Abingdon Science Park, Abingdon, Oxon, OX14 3YT.

Disposal of Batteries and Product



The crossed-out wheellie bin symbols on products and batteries, or on their respective packaging, indicates they must not be disposed of in domestic waste as they contain substances that can be damaging to the environment and human health.



The chemical symbols Hg, Cd or Pb, where marked, indicate that the battery contains more than the specified value of mercury (Hg), cadmium (Cd) or lead (Pb) set out in Battery Directive (2006/66/EC).

The solid bar indicates that the product was placed on the market after 13th August, 2005.



Help protect the environment by disposing of your product or batteries responsibly.

Declaration of Conformity

This product is intended for use within Europe and UK.

This equipment complies with the essential requirements to EU's Radio Equipment Directive (2014/53/EU) and the UK's Radio Regulations 2017 on radio systems and telecommunication equipment.

LeapFrog Enterprises, Inc., a subsidiary of VTech Holdings Limited hereby declares that LF2415 is in compliance with the essential requirements and other relevant provisions of EU's Radio Equipment Directive (2014/53/EU) and UK's Radio Equipment Regulations 2017.

The Declaration of Conformity for the LF2415 is available from leapfrog.com/en-gb/legal/eudoc.



Customer Support



Find the answer to your questions. Get assisted at your own pace using our knowledge-rich full Online Manual, or contact Customer Support with your inquiries.



Scan the QR code to access the Online Manual or visit leapfrog.com/en-gb/support.

Technical Specifications

| | |
|---------------------------------------|---|
| Frequency Control | Crystal controlled PLL synthesizer |
| Channels | 32 |
| Frequency | Baby unit: 2405 - 2475 MHz Parent Viewer: 2405 - 2475 MHz |
| LCD | 5" Colour LCD (WQVGA 480x272 pixel) |
| Power requirements | Parent Viewer: 3.6V, 2600mAh Li-ion, 9.36Wh Li-ion battery Baby unit power adaptor: Output: 5V DC @ 600mA Parent Viewer power adaptor: Output: 5V DC @ 1A |
| Maximum power used by the transmitter | 0.1 W (100 mW) |



Specifications are subject to change without notice.
© 2024 LeapFrog Enterprises, Inc.
a subsidiary of VTech Holdings Limited.
All rights reserved. 01/30. LF2415_UK_QSG_V2

