



# 7" High Definition Pan & Tilt Monitor

LF920HD  
LF920-2HD



## Parent Guide

This guide contains important information.  
Please keep it for future reference.

## Need help?

Visit [leapfrog.com/support](http://leapfrog.com/support)

Visit our website [leapfrog.com](http://leapfrog.com) for more information  
about products, downloads, resources and more.

Read our complete warranty policy online at  
[leapfrog.com/warranty](http://leapfrog.com/warranty).



Scan the QR code  
to enter the  
Online Manual:



Or go to [www.leapfrog.zendesk.com](http://www.leapfrog.zendesk.com)

# Important Safety Instructions

The applied nameplate is located at the bottom of the Baby Unit's base. When using your equipment, basic safety precautions should always be followed to reduce the risk of fire, electric shock and injury, including the following:

1. Follow all warnings and instructions marked on the product.
2. Adult setup is required.
3. **CAUTION:** Do not install the Baby Unit at a height above 2 meters.
4. This product is not a substitute for adult supervision of the infant. Supervising the infant is the parent's or caregiver's responsibility. This product could cease operating, and therefore you should not assume it will continue working properly for any given period of time. Further, this is not a medical device and should not be used as such. This product is intended to assist you in supervising your baby.
5. Do not use this product near water. For example, do not use it next to a bath tub, wash bowl, kitchen sink, laundry tub or swimming pool, or in a wet basement or shower.
6. **CAUTION:** Use only the battery provided. There may be a risk of explosion if a wrong type of battery is used for the Parent Viewer. The battery cannot be subjected to high or low extreme temperature and low air pressure at high altitude during use, storage or transportation. Disposal of battery into fire or a hot oven, or mechanically crushing or cutting or the battery can result in an explosion. Leaving the battery in an extremely high temperature surrounding environment can result in an explosion or the leakage of flammable liquid of gas. Battery subjected to extremely low air pressure may result in an explosion or the leakage of flammable liquid or gas. Dispose of used battery according to the information in **The RBRC seal**.
7. Use only the adapters included with this product. Incorrect adapter polarity or voltage can seriously damage the product.



Power adapter information:

Baby Unit output: Output: 5V DC 1.5A; VTech  
Telecommunications Ltd.; Model: VT05EUS05150  
Parent Viewer output: Output: 5V DC 2A; VTech  
Telecommunications Ltd.; Model: VT07EUS05200



Rechargeable battery information:



Zhuhai Great Power Energy Co., Ltd.; Lithium battery, 3.7V  
5000mAh; Model: GSP806090-5Ah-3.7V-1S1P

8. The power adapters are intended to be correctly oriented in a vertical or floor mount position. The prongs are not designed to hold the plug in place if it is plugged into a ceiling, under-the-table or cabinet outlet.
9. For pluggable equipment, the socket-outlet shall be installed near the equipment and shall be easily accessible.
10. Unplug this product from the wall outlet before cleaning.
11. Do not use liquid or aerosol cleaners. Use a damp cloth for cleaning. Do not cut off the power adapters to replace them with other plugs, as this causes a hazardous situation.
12. Do not allow anything to rest on the power cords. Do not install this product where the cords may be walked on or crimped.
13. This product should be operated only from the type of power source indicated on the marking label. If you are not sure of the type of power supply in your home, consult your dealer or local power company.
14. Do not overload wall outlets or use an extension cord.
15. Do not place this product on an unstable table, shelf, stand or other unstable surfaces.
16. This product should not be placed in any area where proper ventilation is not provided. Slots and openings in the back or bottom of this product are provided for ventilation. To protect them from overheating, these openings must not be blocked by placing the product on a soft surface such as a bed, sofa or rug. This product should never be placed near or over a radiator or heat register.

17. Never push objects of any kind into this product through the slots because they may touch dangerous voltage points or create a short circuit. Never spill liquid of any kind on the product.
18. To reduce the risk of electric shock, do not disassemble this product, but take it to an authorized service facility. Opening or removing parts of the product other than specified access doors may expose you to dangerous voltages or other risks. Incorrect reassembling can cause electric shock when the product is subsequently used.
19. You should test the sound reception every time you turn on the units or move one of the components.
20. Periodically examine all components for damage.
21. There is a very low risk of privacy loss when using certain electronic devices, such as baby monitors, cordless telephones, etc. To protect your privacy, make sure the product has never been used before purchase, reset the baby monitor periodically by powering off and then powering on the units, and power off the baby monitor if you will not use it for some time.
22. Children should be supervised to ensure that they do not play with the product.
23. The product is not intended for use by persons (including children) with reduced physical, sensory or mental capabilities, or lack of experience and knowledge, unless they have been given supervision or instruction concerning use of the appliance by a person responsible for their safety.

## SAVE THESE INSTRUCTIONS

### Cautions

1. Use and store the product at a temperature between 32°F and 104°F.
2. Do not expose the product to extreme cold, heat or direct sunlight. Do not put the product close to a heating source.
3. Batteries should not be exposed to excessive heat such as bright sunshine or fire.
4.  Warning—Strangulation Hazard—Children have STRANGLED in cords. Keep this cord out of the reach of children (more than 3 ft (0.9m) away). Do not remove this tag. 
5. Never place the Baby Unit(s) inside the baby's crib or playpen. Never cover the Baby Unit(s) or Parent Viewer with anything such as a towel or a blanket.
6. Other electronic products may cause interference with your baby monitor. Try installing your baby monitor as far away from these electronic devices as possible: wireless routers, radios, cellular telephones, intercoms, room monitors, televisions, personal computers, kitchen appliances and cordless telephones.

### Precautions for users of implanted cardiac pacemakers

Cardiac pacemakers (applies only to digital cordless devices): Wireless Technology Research, LLC (WTR), an independent research entity, led a multidisciplinary evaluation of the interference between portable wireless devices and implanted cardiac pacemakers. Supported by the U.S. Food and Drug Administration, WTR recommends to physicians that:

#### Pacemaker patients

- Should keep wireless devices at least six inches from the pacemaker.
  - Should NOT place wireless devices directly over the pacemaker, such as in a breast pocket, when it is turned ON.
- WTR's evaluation did not identify any risk to bystanders with pacemakers from other persons using wireless devices.

#### Electromagnetic fields (EMF)

This LeapFrog product complies with all standards regarding electromagnetic fields (EMF). If handled properly and according to the instructions in this user's manual, the product is safe to be used based on scientific evidence available today.

# What's Included

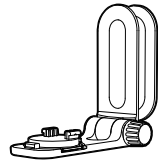
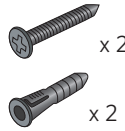
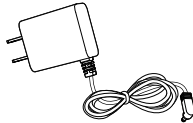
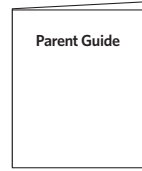
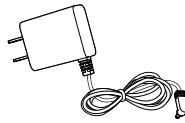
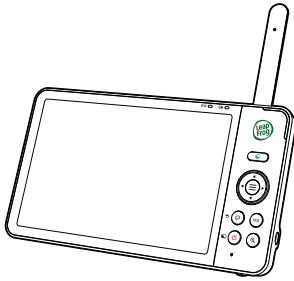

1 set for LF920HD  
2 sets for LF920-2HD

# Connect, Charge, and Power On the Baby Monitor

## 1. Connect the Baby Monitor

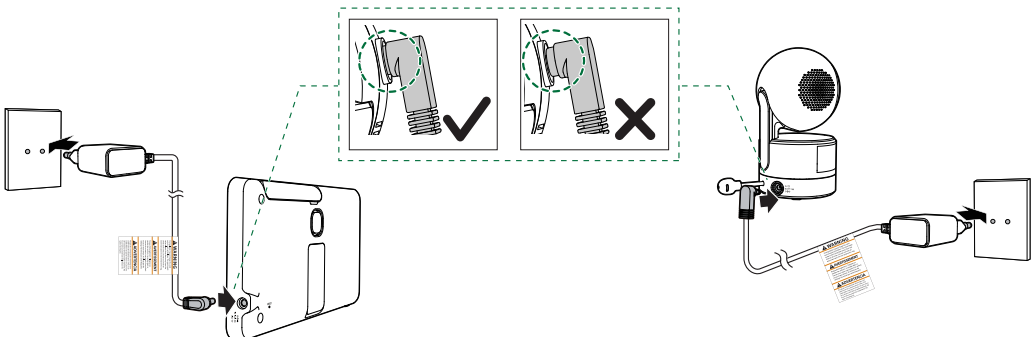



## 2. Charge the Parent Viewer Battery

### Notes:

- Before using the baby monitor for the first time, charge the Parent Viewer battery for 12 hours. When the Parent Viewer battery is fully charged, the battery icon becomes solid .
- The standby time varies depending on your actual usage time and the age of the battery.

The battery icon on the screen indicates the battery status:

Battery Indicators	Battery Status	Action
The screen displays  . The  light flashes.	The battery is low in power and may only be used for a short time.	Charge without interruption (about 30 minutes).
The battery icon becomes solid  .	The battery is fully charged.	To keep the battery charged, connect it to AC power when not in use.

## 3. Power On or Off the Baby Monitor

1. Slide the On/Off switch to **ON** to power on your Baby Unit.
2. Press and hold  until the welcome screen appears.



### Note:

- POWER LED Light is OFF by default.

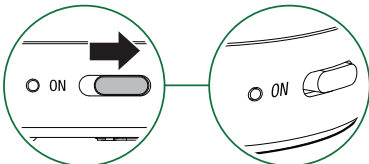
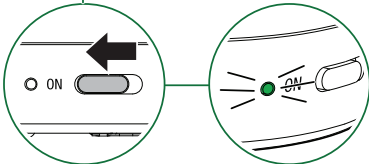

## 4. Status Check

Once your Baby Unit and Parent Viewer are powered on and connected, your Parent Viewer displays video from the Baby Unit, and the  LINK LED light turns on. The Baby Unit's POWER LED light also turns on.

## 4. Positioning the Baby Monitor

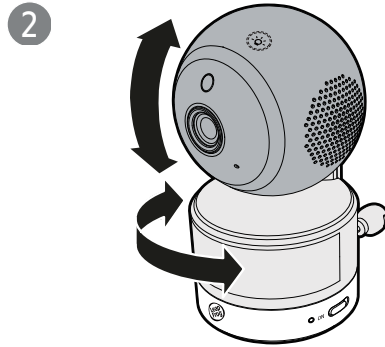
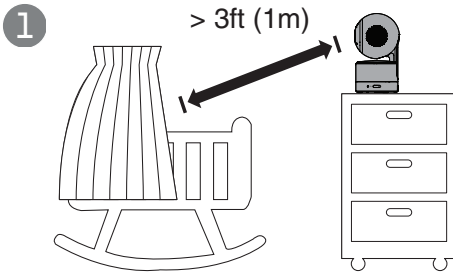

### Tip: Want to mount Baby Unit on the wall?

Visit our Online Manual to find the wall mounting tutorial video and step-by-step guide.

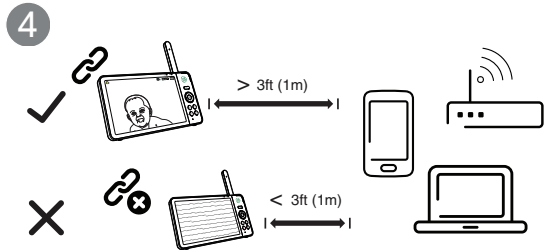
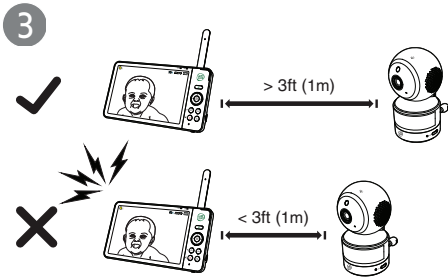

### Note:

To avoid interference from other electronic devices, place your baby monitor at least 3 feet (1 meter) away from devices such as wireless routers, microwaves, cell phones and computers.

### Caution:

The default volume of your Parent Viewer is level 3, and the maximum volume is level 5. If you experience a screeching noise from your baby monitor while positioning:

- Make sure your Baby Unit and Parent Viewer are more than 3 feet (1 meter) apart, **OR**
- Lower the volume of your Parent Viewer.

# Overview

## Parent Viewer

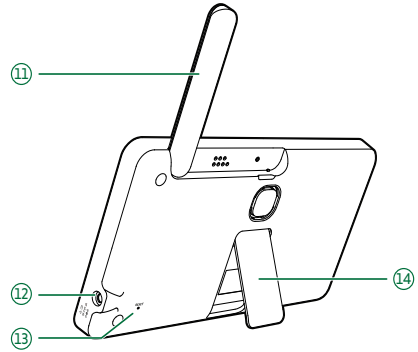
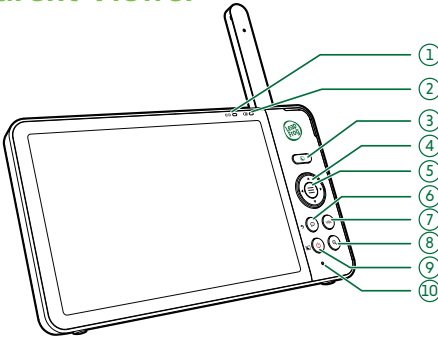

- |   |  |   |
|---|--|---|
| <p><b>1</b>  Link LED light</p> <p><b>2</b>  Battery LED light</p> <p><b>3</b> 3-level sound indicator light</p> <p><b>4</b>  Night Mode quick set key</p> <ul style="list-style-type: none"> <li>▪ Select black-and-white or color night vision viewing mode.</li> <li>▪ Adjust night light brightness.</li> </ul> | <p><b>5</b>  Arrow Keys</p> <p><b>6</b>  Menu / Select</p> <p><b>7</b>  Talk / Return</p> <p><b>8</b> Microphone</p> <p><b>9</b> <b>VOL</b> Volume</p> <ul style="list-style-type: none"> <li>▪ View the volume adjustment bar.</li> </ul> | <p><b>10</b>  Zoom</p> <p><b>11</b>  Power / LCD Off</p> <p><b>12</b> Antenna</p> <p><b>13</b> Power jack</p> <p><b>14</b> RESET</p> <p><b>15</b> Stand</p> |
|---|--|---|

## Baby Unit

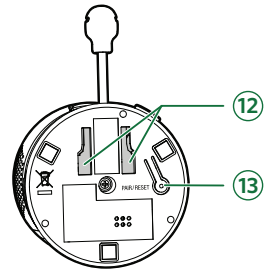
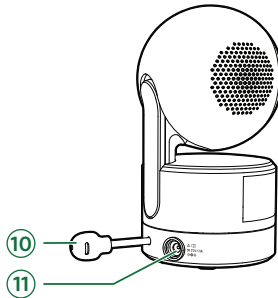
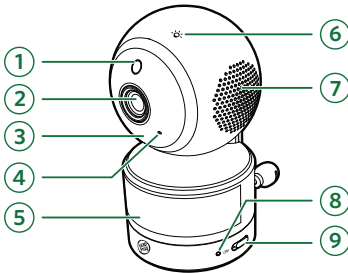

- |   |  |
|---|--|
| <p><b>1</b> Light sensor</p> <p><b>2</b> Camera</p> <p><b>3</b> Infrared LEDs</p> <p><b>4</b> Microphone</p> <p><b>5</b> Night light</p> <p><b>6</b>  Night light control key</p> <ul style="list-style-type: none"> <li>▪ Press to turn the night light on or off.</li> <li>▪ <u>Press and hold</u> to adjust night light brightness level.</li> </ul> | <p><b>7</b> Speaker</p> <p><b>8</b> POWER LED Light</p> <p><b>9</b> On / Off switch</p> <p><b>10</b> Temperature sensor</p> <ul style="list-style-type: none"> <li>▪ Position horizontally for optimal usage.</li> </ul> <p><b>11</b> Power jack</p> <p><b>12</b> Wall mount holes</p> <p><b>13</b> PAIR / Reset key</p> <ul style="list-style-type: none"> <li>▪ The Parent Viewer and Baby Unit(s) provided are already paired.</li> </ul> |
|---|--|

# The RBRC seal



The RBRC seal on the V-Tech battery indicates that Li-ion Communications, Inc. is voluntarily participating in an industry program to collect and recycle these batteries at the end of their useful lives, when taken out of service within the United States and Canada. The program provides a convenient alternative to placing used Li-ion batteries into the trash or municipal waste, which may be illegal in your area. V-Tech's participation makes it easy for you to drop off the spent battery at local retailers participating in the program or at authorized V-Tech product service centers. Please call 1 (800) 8 BATTERY for information on Li-ion battery recycling and disposal bans/restrictions in your area. V-Tech's involvement in this program is part of its commitment to protecting our environment and conserving natural resources. The RBRC Seal and 1 (800) 8 BATTERY® are registered trademarks of Call2recycle, Inc.

# California Energy Commission battery charging testing mode

This baby monitor meets the California Energy Commission (CEC) regulations for energy consumption. Your baby monitor is set up to comply with the energy-conserving standards right out of the box. Follow the instructions to install and charge the battery. The CEC battery charging testing mode is activated while charging. Even if the Parent Viewer is paired to Baby Units, the CEC battery charging testing mode is activated while it is powered off and charging.

# Disclaimer and Limitation For cETL compliance only of Liability

LeapFrog and its suppliers assume no responsibility for any damage or loss resulting from the use of this handbook. LeapFrog and its suppliers assume no responsibility for any loss or claims by third parties that may arise through the use of this software. LeapFrog and its suppliers assume no responsibility for any damage or loss caused by deletion of data as a result of malfunction, dead battery, or repairs. Be sure to make backup copies of important data on other media to protect against data loss.

THIS DEVICE COMPLIES WITH PART 15 OF THE FCC RULES. OPERATION IS SUBJECT TO THE FOLLOWING TWO CONDITIONS: (1) THIS DEVICE MAY NOT CAUSE HARMFUL INTERFERENCE, AND (2) THIS DEVICE MUST ACCEPT ANY INTERFERENCE RECEIVED, INCLUDING INTERFERENCE THAT MAY CAUSE UNDESIRABLE OPERATION.

### CAN ICES-3 (B)/NMB-3(B)

**Caution:** Changes or modifications not expressly approved by the party responsible for compliance could void the user's authority to operate the equipment.

**Warranty:** Please visit our website at leapfrog.com for full details of the warranty provided in your country.

# FCC and IC regulations

FCC Part 15

This equipment has been tested and found to comply with the requirements for a Class B digital device under Part 15 of the Federal Communications Commission (FCC) rules. These requirements are intended to provide reasonable protection against harmful interference in a residential installation. This equipment generates, uses and can radiate radio frequency energy and, if not installed and used in accordance with the instructions, may cause harmful interference to radio communications. However, there is no guarantee that interference will not occur in a particular installation. If this equipment does cause harmful interference to radio or television reception, which can be determined by turning the equipment off and on, the user is encouraged to try to correct the interference by one or more of the following measures:

- Reorient or relocate the receiving antenna.
- Increase the separation between the equipment and receiver.
- Connect the equipment into an outlet on a circuit different from that to which the receiver is connected.
- Consult the dealer or an experienced radio/TV technician for help.

**WARNING:** Changes or modifications to this equipment not expressly approved by the party responsible for compliance could void the user's authority to operate the equipment.

This device complies with Part 15 of the FCC rules. Operation is subject to the following two conditions: (1) This device may not

cause harmful interference, and (2) this device must accept any interference received, including interference that may cause undesired operation.

To ensure safety of users, the FCC has established criteria for the amount of radio frequency energy that can be safely absorbed by a user or bystander during the intended usage of the product. This product has been tested and found to comply with the FCC criteria. The Baby Unit shall be installed and used such that parts of all persons' body are maintained at a distance of approximately 8 in (20 cm) or more. The transmitter and antenna of the Parent Viewer shall be held at least 1 in (2.5 cm) from your face.

This Class B digital apparatus complies with Canadian requirement: CAN ICES-3 (B)/NMB-3(B)

### Industry Canada

This device contains licence-exempt transmitter(s)/receiver(s) that comply with Innovation, Science and Economic Development Canada's licence-exempt RSS's. Operation is subject to the following two conditions: (1) This device may not cause interference. (2) This device must accept any interference, including interference that may cause undesired operation of the device.

The term "IC:" before the certification/registration number only signifies that the Industry Canada technical specifications were met.

This product meets the applicable Innovation, Science and Economic Development Canada technical specifications.

### RF radiation exposure statement

The product complies with FCC RF radiation exposure limits set forth for an uncontrolled environment. The Baby Unit should be installed and operated with a minimum distance of 8 in (20 cm) between the Baby Unit and all persons' body. Use of other accessories may not ensure compliance with FCC RF exposure guidelines. This equipment complies also with Industry Canada RSS-102 with respect to Canada's Health Code 6 for Exposure of Humans to RF fields.

### Mesures de sécurité importantes

La plaque signalétique appliquée est située au bas du socle de l'unité du bébé.

Lorsque vous utilisez votre appareil, vous devriez toujours suivre certaines mesures de précaution de base afin de réduire les risques d'incendie, d'électrocution et de blessures corporelles, dont ceux qui suivent :

1. Observez toutes les instructions et mises en garde inscrites sur l'appareil.
2. MISE EN GARDE: N'installez pas l'unité du bébé à une hauteur supérieure à 2 mètres.
3. Ce produit ne remplace pas la surveillance adulte du nourrisson. La supervision du nourrisson est la responsabilité du parent ou de la personne qui s'occupe de l'enfant. Ce produit pourrait cesser de fonctionner et, par conséquent, vous ne devriez pas présumer qu'il continuera de fonctionner correctement pendant une période de temps donnée. De plus, il ne s'agit pas d'un instrument médical et ne devrait pas être utilisé comme tel. Ce produit est destiné à vous aider à superviser votre bébé.
4. N'utilisez pas cet appareil près de l'eau ni de toute autre source d'humidité, par exemple, près d'une baignoire, cuve à lessive, évier de cuisine, dans un sous-sol humide ni près d'une piscine, dans un sous-sol humide ou une douche.
5. MISE EN GARDE: Utilisez uniquement la pile fournie. Un risque d'explosion pourrait survenir si un mauvais type de pile est utilisé pour l'unité du parent. La pile ne peut pas être soumise à des températures extrêmes élevées ou basses et à une faible pression d'air à haute altitude pendant l'utilisation, l'entreposage ou le transport. L'élimination de la pile dans le feu ou dans un four chaud, ou écrasement ou le découpage mécanique de la pile peuvent entraîner une explosion. Laisser la pile dans un environnement à température extrêmement élevée peut entraîner une explosion ou la fuite d'un liquide ou d'un gaz inflammable. Une pile soumise à une pression d'air extrêmement basse peut provoquer une explosion ou une fuite de liquide ou de gaz inflammable. Éliminer la pile usagée conformément aux informations du Sceau RBRC.
7. N'utilisez que les adaptateurs inclus avec ce produit. L'utilisation d'un adaptateur dont la polarité ou la tension serait inadéquate risque d'endommager sérieusement le produit et mettre votre sécurité en péril.

Informations sur les adaptateurs électriques : Adaptateur de l'unité du parent : Sortie : 5V DC 2A V-Tech Telecommunications Ltd. Modèle : VT07EUS05200 Adaptateur de l'unité du bébé : Sortie : 5V DC 1.5A V-Tech Telecommunications Ltd. Modèle : VT05EUS05150

Informations sur les piles rechargeables : Zhihui Great Power Energy Co., Ltd. Lithium battery, 3.7V 5000mAh; Modèle: GSP80690-5Ah-3.7V-15P

8. Lorsqu'ils sont branchés dans une prise de courant, les adaptateurs secteur ont été conçus pour être orientés correctement, soit à la verticale ou au plancher. Les broches n'ont pas été conçues pour supporter le poids du bloc d'alimentation et le maintenir en place si celui-ci est branché dans une prise au plafond, sous une table ou dans un meuble.
9. Pour les PRODUITS À BRANCHER À UNE PRISE DE COURANT, la

prise de courant doit être installée près du produit, afin d'assurer une accessibilité sécuritaire à la prise de courant.

10. Débranchez ce produit de la prise de courant avant de procéder au nettoyage. N'utilisez pas de nettoyeurs en aérosols. Utilisez un chiffon humide pour le nettoyer.
11. Ne coupez pas les cordons d'alimentation pour remplacer les fiches, car ceci peut présenter un danger potentiel.
12. Ne laissez aucun objet reposer ni appuyer sur le cordon d'alimentation. N'installez pas cet appareil dans un endroit où l'on risque d'écraser le cordon d'alimentation ou de le plier.
13. Ne faites fonctionner cet appareil qu'avec le type d'alimentation indiqué sur l'étiquette. Si vous ne connaissez pas le type d'alimentation que vous possédez à votre domicile, consultez votre marchand ou votre compagnie locale d'électricité.
14. Ne surchargez pas les prises de courant murales ni les rallonges électriques.
15. Ne placez pas cet appareil sur un chariot, meuble, trépied, support de montage ni table chancelantes.
16. Les trous et ouvertures du boîtier, situés à l'arrière de l'appareil ou sous celui-ci, servent à aérer l'appareil. Pour l'empêcher de surchauffer, ne bloquez sous aucun prétexte ces ouvertures et n'empêchez pas l'aération adéquate de l'appareil en le plaçant sur un lit, divan, tapis ou toute autre surface similaire. De même, ne positionnez pas à proximité ni au-dessus d'une source de chaleur ou d'un calorifère. De même, ne placez pas l'appareil dans un endroit avant de vous assurer qu'il y ait une bonne circulation d'air.
17. N'enfoncez jamais d'objets à travers les ouvertures de cet appareil, car il pourrait entrer en contact avec des points de tension dangereux ou causer des courts-circuits qui peuvent dégénérer en incendies ou en risques d'électrocution. Ne renversez jamais de liquide dans ce produit.
18. Afin de réduire les risques d'électrocution, ne démontez pas cet appareil, mais apportez-le dans un centre de service autorisé. L'ouverture du boîtier ou le retrait de toutes pièces que contient cet appareil, à l'exception de l'accès autorisé à certaines portes ou ouvertures, nous expose à des points de tension dangereux ou à d'autres dangers. Un remontage incorrect peut à la suite présenter des risques d'électrocution.
19. Vous devriez tester la réception chaque fois que vous mettez l'appareil en fonction.
20. Examinez les composantes afin de vérifier si celles-ci ne sont pas endommagées.
21. Il existe un très faible risque de perte de confidentialité avec certains appareils électroniques (autres écouteurs-bébé, téléphones sans fils etc.). Pour l'éviter, s'assurer que le produit n'a jamais été utilisé avant l'achat, réinitialiser l'unité de façon périodique, éteindre l'écoute-bébé quand il n'est pas en cours d'utilisation.
22. Les enfants devraient être supervisés afin de vous assurer qu'ils ne touchent pas l'appareil.
23. Ne laissez jamais l'appareil être utilisé par des personnes (incluant des enfants) aux capacités physiques, sensorielles ou mentales réduites ou qui manquent d'expérience et de connaissances, à moins qu'on leur ait donné suffisamment de supervision ou d'instructions relativement à l'utilisation de l'appareil par une personne responsable de leur sécurité.

### CONSERVEZ CES INSTRUCTIONS

Mises en garde

1. Utilisez et entreposez le produit à une température entre 0 °C (32°F) et 40 °C (104°F).
2. N'exposez pas cet appareil à des froids ou des chaleurs extrêmes, ainsi qu'à la lumière directe du soleil. Ne l'installez pas près d'une source de chauffage.
3. Le bloc-piles ne doit pas être exposé à la chaleur excessive telle que la lumière du soleil ou au feu.
4. Avertissement - Risque de strangulation - Les enfants se sont ÉTRANGLES dans des cordons. Gardez ce cordon hors de portée des enfants (à plus de 0,9 m). N'enlevez pas cette étiquette.
5. Ne jamais placer le moniteur à l'intérieur du berceau ou du parc de bébé. Ne jamais couvrir le moniteur ou l'unité (s) portable avec un article tel une serviette ou une couverture.
6. D'autres équipements électroniques peuvent produire des interférences sur votre moniteur vidéo et audio. Tentez d'installer votre moniteur vidéo et audio à l'écart des appareils électroniques tels que des routeurs sans fils, radios, téléphones cellulaires, interphones, moniteurs, téléphones, ordinateurs personnels, électroménagers et téléphones sans fil.

Stimulateurs cardiaques implantés dans l'organisme  
Les simulateurs cardiaques (ne s'applique qu'aux dispositifs numériques sans fil) :

- L'organisme Wireless Technology Research, LLC (WTR), une firme de recherche indépendante, a mené une évaluation pluridisciplinaire des interférences entre les téléphones sans fil portatifs et les stimulateurs cardiaques implantés dans l'organisme. Appuyée par l'Administration des aliments et drogues (FDA) des États-Unis, la firme WTR recommande aux médecins:
- Avis aux détenteurs de stimulateurs cardiaques
- Vous devriez maintenir les dispositifs sans fil à au moins six pouces du stimulateur cardiaque.
- Ils ne doivent PAS placer le téléphone sans fil directement sur le stimulateur cardiaque, tel que dans une poche de chemise, lorsque celui-ci est en marche.

L'étude effectuée par l'organisme WRS n'a pas identifié de risque pour les détenteurs de stimulateurs cardiaques causés par les gens qui utilisent des dispositifs sans fil à proximité de ceu-ci.

Champs électromagnétiques (EMF)  
Ce produit de LeapFrog est conforme à toutes les normes se rapportant aux champs électromagnétiques (EMF) standard. Si vous le manipulez correctement en suivant les instructions de ce guide, son utilisation sera sécuritaire pendant de nombreuses années, selon les meilleures évidences scientifiques dont nous disposons aujourd'hui.

## Online Manual



Find the answer to your question on our knowledge-rich Online Manual. Get assisted at your own pace and learn what your monitor is capable of.



Scan the QR code to access the Online Manual or visit [www.leapfrog.zendesk.com](http://www.leapfrog.zendesk.com).



### Full Manual

Comprehensive help articles on product set up, operations, Wi-Fi and settings.



### Video Tutorials

Walk-throughs on features and installation such as mounting the Baby Unit on the wall.



### FAQs & Troubleshooting

Answers to the most commonly asked questions, including troubleshooting solutions.

## Customer Support



Visit our Consumer Support website 24 hours a day at:

**United States:**

[leapfrog.com/support](http://leapfrog.com/support)

**Canada:**

[leapfrog.ca/support](http://leapfrog.ca/support)



Call our Customer Service number from Monday to Friday

9am - 6pm Central Time:

**United States & Canada:**

1 (800) 701-5327

## Warranty

Please visit our website at [leapfrog.com](http://leapfrog.com) for full details of the warranty provided in your country.

## Technical Specifications

Frequency control	Crystal controlled PLL synthesizer
Transmit frequency	Baby Unit: 2.406-2.475GHz Parent Viewer: 2.406-2.475GHz
Channels	32
LCD	7" Color LCD (IPS 1280x800 pixels)
Nominal effective range	Maximum power allowed by FCC and IC. Actual operating range may vary according to environmental conditions at the time of use.
Power requirements	Parent Viewer: 3.7V 5000mAh Lithium-ion battery Baby Unit power adapter: Output: 5V DC @ 1.5A Parent Viewer power adapter: Output: 5V DC @ 2A

### Credits:

The Background Noise sound file was created by Caroline Ford, and is used under the Creative Commons license. The Stream Noise sound file was created by Caroline Ford, and is used under the Creative Commons license. The Crickets At Night sound file was created by Mike Koenig, and is used under the Creative Commons license. The Heart Beat sound file was created by Zarabadeu, and is used under the Creative Commons license.



Specifications are subject to change without notice.  
© 2021 LeapFrog Enterprises, Inc.  
a subsidiary of VTech Holdings Limited.  
All rights reserved. 08/21. LF920-XHD\_QSG\_V2.