



5" WiFi High Definition PAN & TILT MONITOR

LF925HD
LF925HD-2



Quick Start Guide

This guide contains important information.
Please keep it for future reference.

Need help?

Visit leapfrog.com.au/support

Visit our website leapfrog.com.au for more information about products, downloads, resources and more.



Scan the QR code or go to
leapfrog.com.au/support
to enter our Online Manual.

Important Safety Instructions

The applied nameplate is located at the bottom of the Baby Unit's base. When using your equipment, basic safety precautions should always be followed to reduce the risk of fire, electric shock and injury, including the following:

1. Follow all warnings and instructions marked on the product.
2. Adult setup is required.
3. **CAUTION:** Do not install the Baby Unit at a height above 2 meters.
4. This product is not a substitute for adult supervision of the infant. Supervising the infant is the parent's or caregiver's responsibility. This product could cease operating, and therefore you should not assume it will continue working properly for any given period of time. Further, this is not a medical device and should not be used as such. This product is intended to assist you in supervising your baby.
5. Do not use this product near water. For example, do not use it next to a bath tub, wash bowl, kitchen sink, laundry tub or swimming pool, or in a wet basement or shower.
6. **CAUTION:** Use only the battery provided. There may be a risk of explosion if a wrong type of battery is used for the Parent unit. The battery cannot be subjected to high or low extreme temperature and low air pressure at high altitude during use, storage or transportation. Disposal of battery into fire or a hot oven, or mechanically crushing or cutting or the battery can result in an explosion. Leaving the battery in an extremely high temperature surrounding environment can result in an explosion or the leakage of flammable liquid or gas. Battery subjected to extremely low air pressure may result in an explosion or the leakage of flammable liquid or gas. Dispose of used battery according to the instructions.
7. Use only the adapters included with this product. Incorrect adapter polarity or voltage can seriously damage the product.



Power adapter information:

Baby Unit Output: 5V DC 1.5A;
VTech Telecommunications Ltd.; Model: VT07EAU05150
Parent unit Output: 5V DC 2A;
VTech Telecommunications Ltd.; Model: VT07EAU05200



Rechargeable battery information:



Zhuohai Great Power Energy Co., Ltd.; Lithium battery,
3.7V 5000mAh; Model: GSP806090-5Ah-3.7V-1S1P

8. The power adapters are intended to be correctly oriented in a vertical or floor mount position. The prongs are not designed to hold the plug in place if it is plugged into a ceiling, under-the-table or cabinet outlet.
9. For pluggable equipment, the socket-outlet shall be installed near the equipment and shall be easily accessible.
10. Unplug this product from the wall outlet before cleaning.
11. Do not use liquid or aerosol cleaners. Use a damp cloth for cleaning. Do not cut off the power adapters to replace them with other plugs, as this causes a hazardous situation.
12. Do not allow anything to rest on the power cords. Do not install this product where the cords may be walked on or crimped.
13. This product should be operated only from the type of power source indicated on the marking label. If you are not sure of the type of power supply in your home, consult your dealer or local power company.
14. Do not overload wall outlets or use an extension cord.
15. Do not place this product on an unstable table, shelf, stand or other unstable surfaces.
16. This product should not be placed in any area where proper ventilation is not provided. Slots and openings in the back or bottom of this product are provided for ventilation. To protect them from overheating, these openings must not be blocked by placing the product on a soft surface such as a bed, sofa or rug. This product should never be placed near or over a radiator or heat register.

17. Never push objects of any kind into this product through the slots because they may touch dangerous voltage points or create a short circuit. Never spill liquid of any kind on the product.
18. To reduce the risk of electric shock, do not disassemble this product, but take it to an authorized service facility. Opening or removing parts of the product other than specified access doors may expose you to dangerous voltages or other risks. Incorrect reassembling can cause electric shock when the product is subsequently used.
19. You should test the sound reception every time you turn on the units or move one of the components.
20. Periodically examine all components for damage.
21. There is a very low risk of privacy loss when using certain electronic devices, such as baby monitors, cordless telephones, etc. To protect your privacy, make sure the product has never been used before purchase, reset the baby monitor periodically by powering off and then powering on the units, and power off the baby monitor if you will not use it for some time.
22. Children should be supervised to ensure that they do not play with the product.
23. The product is not intended for use by persons (including children) with reduced physical, sensory or mental capabilities, or lack of experience and knowledge, unless they have been given supervision or instruction concerning use of the appliance by a person responsible for their safety.

SAVE THESE INSTRUCTIONS

Cautions

1. Use and store the product at a temperature between 32°F (0°C) and 104°F (40°C).
2. Do not expose the product to extreme cold, heat or direct sunlight. Do not put the product close to a heating source.
3. Batteries should not be exposed to excessive heat such as bright sunshine or fire.
4.  Warning—Strangulation Hazard—Children have STRANGLED in cords. Keep this cord out of the reach of children (more than 3 ft (0.9m) away). Do not remove this tag. 
5. Never place the Baby Unit(s) inside the baby's cot or playpen. Never cover the Baby Unit(s) or Parent unit with anything such as a towel or a blanket.
6. Other electronic products may cause interference with your baby monitor. Try installing your baby monitor as far away from these electronic devices as possible: wireless routers, radios, cellular telephones, intercoms, room monitors, televisions, personal computers, kitchen appliances and cordless telephones.

What's Included

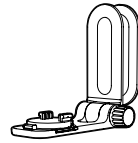
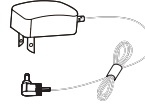
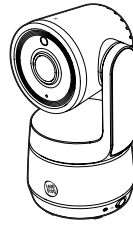
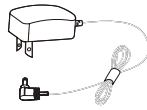
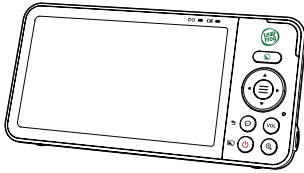

x 2



x 2

1 set for LF925HD
2 set for LF925HD-2



Download LeapFrog Baby Care App

Start monitoring from anywhere.

Scan the QR code to download the free LeapFrog Baby Care mobile app, or search "LeapFrog Baby Care" on Apple App Store or Google Play Store.



App Compatibility

- Android™ 6.0 or later
- iOS 12.0 or later.

Connect, Charge, and Power On the Baby Monitor

1. Connect the Baby Monitor

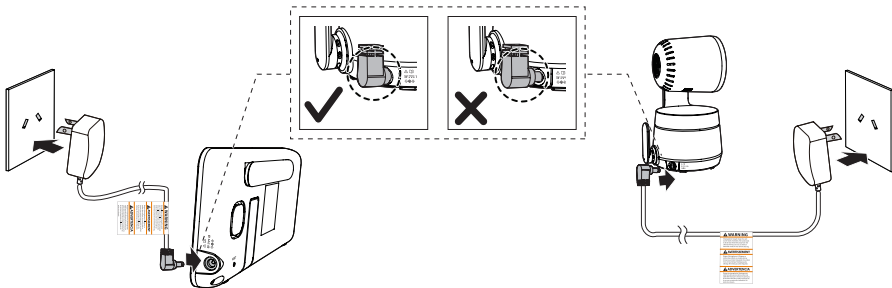

2. Charge the Parent unit Battery

Notes:

- Before using the baby monitor for the first time, charge the Parent unit battery for 12 hours. When the Parent unit battery is fully charged, the battery icon becomes solid .
- The standby time varies depending on your actual usage time and the age of the battery.

3. Power On or Off the Baby Monitor

1. Slide the On/Off switch to **ON** to power on your Baby Unit.
2. Press and hold  until the welcome screen appears.

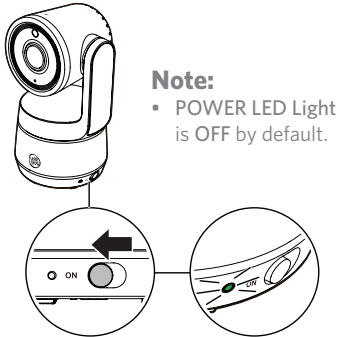

4. Status Check

Once your Baby Unit and Parent unit are powered on and connected, your Parent unit displays video from Baby Unit, and the  LINK LED light turns on.

5. Positioning the Baby Monitor

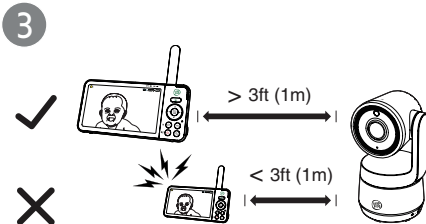
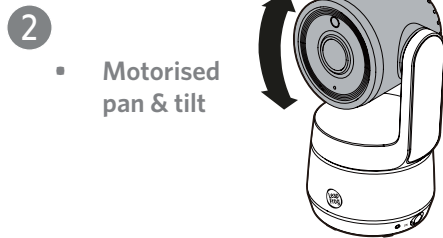
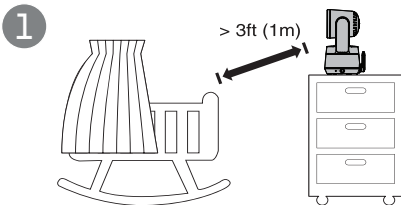

Note:

To avoid interference from other electronic devices, place your baby monitor at least 3 feet (1 meter) away from devices such as wireless routers, microwaves, cell phones and computers.

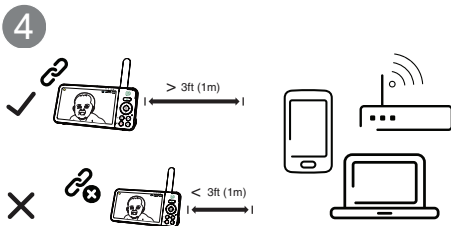

Caution:

The default volume of your Parent unit is level 3, and the maximum volume is level 5. If you experience a screeching noise from your baby monitor while positioning:

- Make sure your Baby Unit and Parent unit are more than 3 feet (1 meter) apart, **OR**
- Lower the volume of your Parent unit.

Tip: Want to mount Baby Unit on the wall?

Visit our Online Manual to find the wall mounting tutorial video and step-by-step guide.

Overview

Parent unit

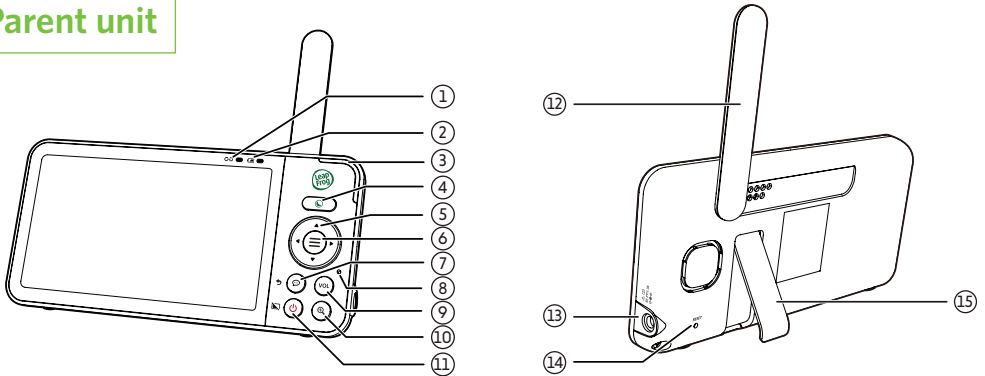

- | | | |
|---|--|----------------------------|
| 1 Link LED light | 5 Arrow Keys | 10 Zoom / Help |
| 2 Battery LED light | 6 Menu / Select | 11 Power / LCD Off |
| 3 3-level sound indicator light | 7 Talk / Return | 12 Antenna |
| 4 Night Mode quick set key <ul style="list-style-type: none">Select black-and-white or color night vision viewing mode.Adjust night light brightness. | 8 Microphone | 13 Power jack |
| | 9 VOL Volume <ul style="list-style-type: none">View the volume adjustment bar. | 14 RESET |
| | | 15 Stand |

Baby Unit

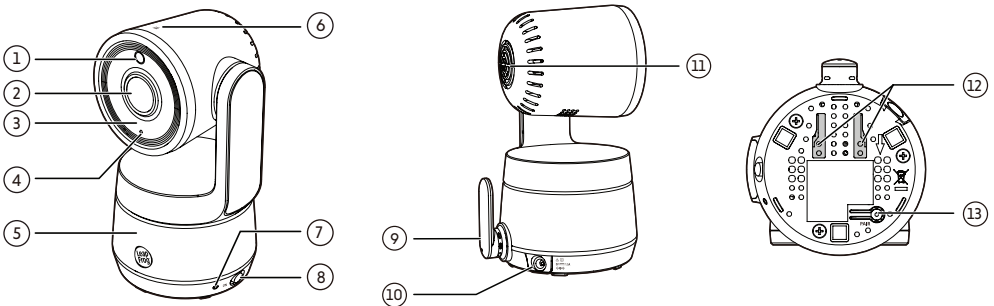

- | | |
|--|--|
| 1 Light sensor | 7 POWER LED Light |
| 2 Camera | 8 On / Off switch |
| 3 Infrared LEDs | 9 Antenna |
| 4 Microphone | 10 Power jack |
| 5 Night light | 11 Speaker |
| 6 Night light control key <ul style="list-style-type: none">Tap to turn the night light on or off<u>Tap and hold</u> to adjust night light brightness level. | 12 Wall mount holes |
| | 13 PAIR key <ul style="list-style-type: none">The Parent unit and Baby Unit(s) provided are already paired. |

Parent Unit Icons

Main Menu Icons

Monitoring mode (For LF925HD-2 only)



- View Baby Units in Single mode.
- View Baby Units in Patrol mode.
- View Baby Units in Split screen.

Night light



- Turn on/off night light.
- Select a night light color.
- Adjust brightness.
- Set a Timer to turn the night light off.

Lullaby



- Play/Stop lullaby.
- Select to play all melodies, or play one of the 5 melodies and 5 soothing sounds.
- Set a Timer to stop the lullaby.
- Set the lullaby volume.

Detection - Sound, motion, temperature



- Select the sound and motion sensitivity level.
- Turn on/off sound and motion detection alerts.
- Turn on/off Auto Wake-up feature.
- Turn on/off Temperature Alert.
- Select the minimum and maximum Temperature range.
- Temperature display format.

Parent Unit settings



- Parent Unit screen brightness
- Turn on/off Low Battery Alert Tone.
- Turn on/off No Link Alert Tone.
- Dim Mode

Baby Unit settings



- Parking Mode
- LED Status
- Baby Unit's speaker volume.
- Security Key

General settings



- Configure Wi-Fi
- Connect Mobile Device
- Reset Settings

Status icon



Direct mode



Parent unit, baby unit 1 and baby unit 2 (*For LF925HD-2 Only) are connected to each others directly.



Wi-Fi Router mode



Parent unit, baby unit 1 and baby unit 2 (*For LF925HD-2 only) are connected to home Wi-Fi network.



Baby unit 1 and 2 are being viewed in **Patrol** mode (*For LF925HD-2 only).



Baby unit 1 and 2 are being viewed in **Split** mode (*For LF925HD-2 only).



B/W night vision is turned on.



Color night vision is turned on.



Motion detection alert is turned on.



Melodies and soothing sounds are playing.



Night light is turned on.



Auto night light brightness is activated.



Parent unit is muted.



Temperature alert is turned on.



Humidity



Temperature



Battery indicator

Two Ways to Connect Your Baby Monitor

Direct mode

The Parent Viewer and the Baby Unit are pre-paired and can connect to each other directly in **Direct mode** by default, which allows you to stream live video right out of the box.

It is NOT recommended to continue using Direct Mode connection after initial installation.

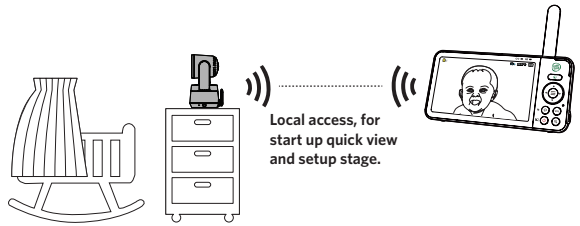

Wi-Fi Router mode

You are required to set up your monitor in **Router mode** to enjoy live video streaming via your Parent Viewer with an enhanced connection. **Router mode** is the recommended mode for stable connectivity.

Router mode uses your home Wi-Fi network to connect your baby monitor system. It supports live video streaming through the Parent Viewer and smartphone app.

With the LeapFrog mobile app, your Wi-Fi router (not included) also provides Internet connectivity to your baby monitor system, allowing you to control your Baby Unit wherever you are.

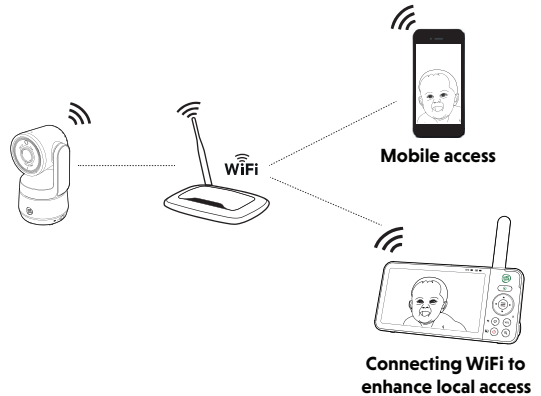

Test the Location

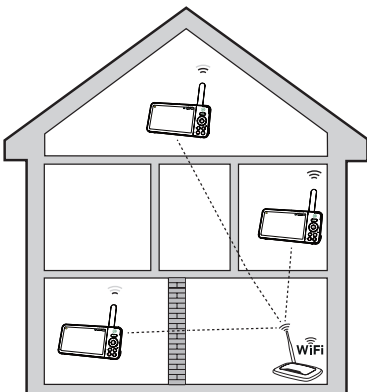

If you plan to install your Baby Unit to a designated location, and will use your home Wi-Fi network to connect your video monitor, test whether your selected monitoring areas have good Wi-Fi signal strength.

Adjust the direction and distance between your Baby Unit, Parent unit, and Wi-Fi router until you have identified a suitable location with good connection.

Protect Your Privacy and Online Security

LeapFrog cares about your privacy and peace of mind. That's why we've put together a list of industry-recommended best practices to help keep your wireless connection private and your devices protected when online.

Ensure your wireless connection is secure

- Before installing a device, ensure your router's wireless signal is encrypted by selecting the "WPA2-PSK with AES" setting in your router's wireless security menu.

Change default settings

- Change your wireless router's default wireless network name (SSID) to something unique.
- Change default passwords to unique, strong passwords. A strong password:
 - Is at least 10 characters long.
 - Does not contain dictionary words or personal information.
 - Contains a mix of uppercase letters, lowercase letters, special characters and numbers.

Keep your devices up to date

- Download security patches from manufacturers as soon as they become available. This will ensure you always have the latest security updates.

- If the feature is available, enable automatic updates for future releases.

Disable Universal Plug and Play (UPnP) on your router

- UPnP enabled on a router can limit the effectiveness of your firewall by allowing other network devices to open inbound ports without any intervention or approval from you. A virus or other malware program could use this function to compromise security for the entire network.

For more information on wireless connections and protecting your data, please review the following resources from industry experts:

1. Federal Communications Commission: Wireless Connections and Bluetooth Security Tips - www.fcc.gov/consumers/guides/how-protect-yourself-online.
2. U.S. Department of Homeland Security: Before You Connect a New Computer to the Internet - www.us-cert.gov/ncas/tips/ST15-003.
3. Federal Trade Commission: Using IP Cameras Safely - <https://www.consumer.ftc.gov/articles/0382-using-ip-cameras-safely>.
4. Wi-Fi Alliance: Discover Wi-Fi Security - <http://www.wi-fi.org/discover-wi-fi/security>.

Parking mode

Designed for extra peace of mind, turn on Parking Mode for a moment of privacy.

When turned on, Baby Unit will fold into the parking position and disable its camera's audio transmission and video monitoring.

In Parking Mode, motion recording, motion detection, and sound detection will be temporarily unavailable.

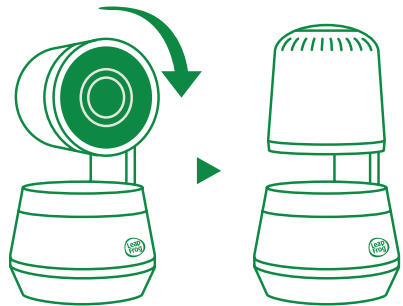

Activate Parking Mode:

1. Press **≡** to enter the main menu.
 2. Go to  **Baby Unit settings**.
 3. Press **▼** to **Parking Mode**, press **≡** and choose "Yes" to toggle the switch on.
- To deactivate Parking Mode and resume normal operation, press **⊕** on Parent unit.

General product care

To keep this product working well and looking good, follow these guidelines:

- Avoid placing it near heating appliances and devices that generate electrical noise (for example, motors or fluorescent lamps).
- DO NOT expose it to direct sunlight or moisture.
- Avoid dropping the product or treating it roughly.
- Clean with a soft damp cloth.
- DO NOT immerse the Parent unit and the Baby Unit in water and do not clean them under running water.
- DO NOT use cleaning spray or liquid cleaners.
- Make sure the Parent unit and the Baby Unit are dry before you connect them to the mains again.
- Clean the USB charging port of dust, dirt, and lint regularly.

Disposal of batteries and product



The crossed-out wheellie bin symbols on products and batteries, or on their respective packaging, indicates they must not be disposed of in domestic waste as they contain substances that can be damaging to the environment and human health.

The chemical symbols Hg, Cd or Pb, where marked, indicate that the battery contains more than the specified value of mercury (Hg), cadmium (Cd) or lead (Pb) set out in Battery Directive (2006/66/EC).

The solid bar indicates that the product was placed on the market after 13th August, 2005.

Help protect the environment by disposing of your product or batteries responsibly.

Customer service and product warranty

IMPORTANT

Please retain this booklet with your sales receipt as proof of the date of purchase.

Customer Service

If you require assistance in operating this product, please call the TechHelp Information Line on 1300 369 193 or contact VTech by e-mail at: tcpsupport_au@vtech.com.

Voluntary Product Enquiry

In addition to your Statutory Rights and subject to the conditions below, VTech warrants that this product will be free from any defect in materials or workmanship under conditions of normal use for a period of 24 months from date of purchase.

VTech does not warrant that the product will be free from defects if defects are caused by an accident, misuse, abuse, improper installation or operation, vermin infestations, lack of reasonable care, unauthorised modification, loss of parts, tampering or attempted repair by a person not authorised by VTech; or where the product has been damaged by lightning or a mains power surge. To make a claim under this Voluntary Product Warranty you must call the TechHelp Information Line on 1300 369 193 or contact VTech by e-mail at: tcpsupport_au@vtech.com where a Customer Service Representative will inform you of the product return process. You will need to ensure that:

- You provide proof of purchase;
- Your product is suitably packaged (original packaging is not required); and
- You have included all components from the original purchase.

For your records

Date of purchase:

Place of purchase:

Serial number:

For Voluntary Product Warranty purposes, proof of purchase is required so please keep your receipt.

The benefits conferred by this Voluntary Product Warranty are in addition to other rights and remedies that are available to you under law, which cannot be excluded. The processes for this Voluntary Product Warranty in no way limit your rights which arise as a result of your Statutory Rights.

This Voluntary Product Warranty is given by:

VTech Telecommunications (Australia) Pty Ltd ABN 70 136 672 627

Address: 24 Gilby Road, Mount Waverley 3149

IMPORTANT NOTE: THIS IS NOT A PRODUCT RETURN OR SERVICE ADDRESS - PLEASE CONTACT TECHHELP BY PHONE OR EMAIL FOR PRODUCT AND WARRANTY SUPPORT. NO LIABILITY WILL BE ACCEPTED BY VTECH FOR PRODUCTS RETURNED TO THIS ADDRESS UNDER THIS VOLUNTARY PRODUCT WARRANTY.

Phone number: 1300 369 193

Email address: tcpsupport_au@vtech.com

Statutory Rights

Our goods come with guarantees that cannot be excluded under the Australian Consumer Law. You are entitled to a replacement or refund for a major failure and compensation for any other reasonably foreseeable loss or damage. You are also entitled to have the goods repaired or replaced if the goods fail to be of acceptable quality and the failure does not amount to a major failure.

Online Manual



Find the answer to your question on our knowledge-rich Online Support Page. Get assisted at your own pace and learn what your monitor is capable of.



Scan the QR code to access the Online Support Page or visit leapfrog.com.au/support

Technical Specifications

Technology	Wi-Fi 2.4GHz 802.11 b/g/n
Channels	13 (2412 - 2462 MHz) Maximum power used by the transmitter: 0.10W (100mW)
Internet Connection	Minimum Requirement: 1.5 Mbps @ 720p or 2.5 Mbps @ 1080p upload bandwidth per Baby Unit
LCD	5" Color LCD (IPS 1280x720 pixels)
Nominal effective range	Actual operating range may vary according to environmental conditions at the time of use.
Power requirements	Parent unit: 3.7V 5000mAh Lithium-ion battery Baby Unit power adapter: Output: 5V DC @ 1.5A Parent unit power adapter: Output: 5V DC @ 2A

Credits:

The Background Noise sound file was created by Caroline Ford, and is used under the Creative Commons license.
The Stream Noise sound file was created by Caroline Ford, and is used under the Creative Commons license.
The Crickets At Night sound file was created by Mike Koenig, and is used under the Creative Commons license.
The Heart Beat sound file was created by Zarabadeu, and is used under the Creative Commons license.

Android™ and Google Play™ are trademarks of Google Inc.

App Store is a trademark of Apple Inc., registered in the U.S. and other countries.

iOS is a trademark or registered trademark of Cisco in the U.S. and other countries and is used under license.



Specifications are subject to change without notice.
© 2023 LeapFrog Enterprises, Inc.
a subsidiary of VTech Holdings Limited.
All rights reserved. 01/23. LF925-XHD_AU_QSG_V3